

walter+bai

w+b

# Cement Testing Systems

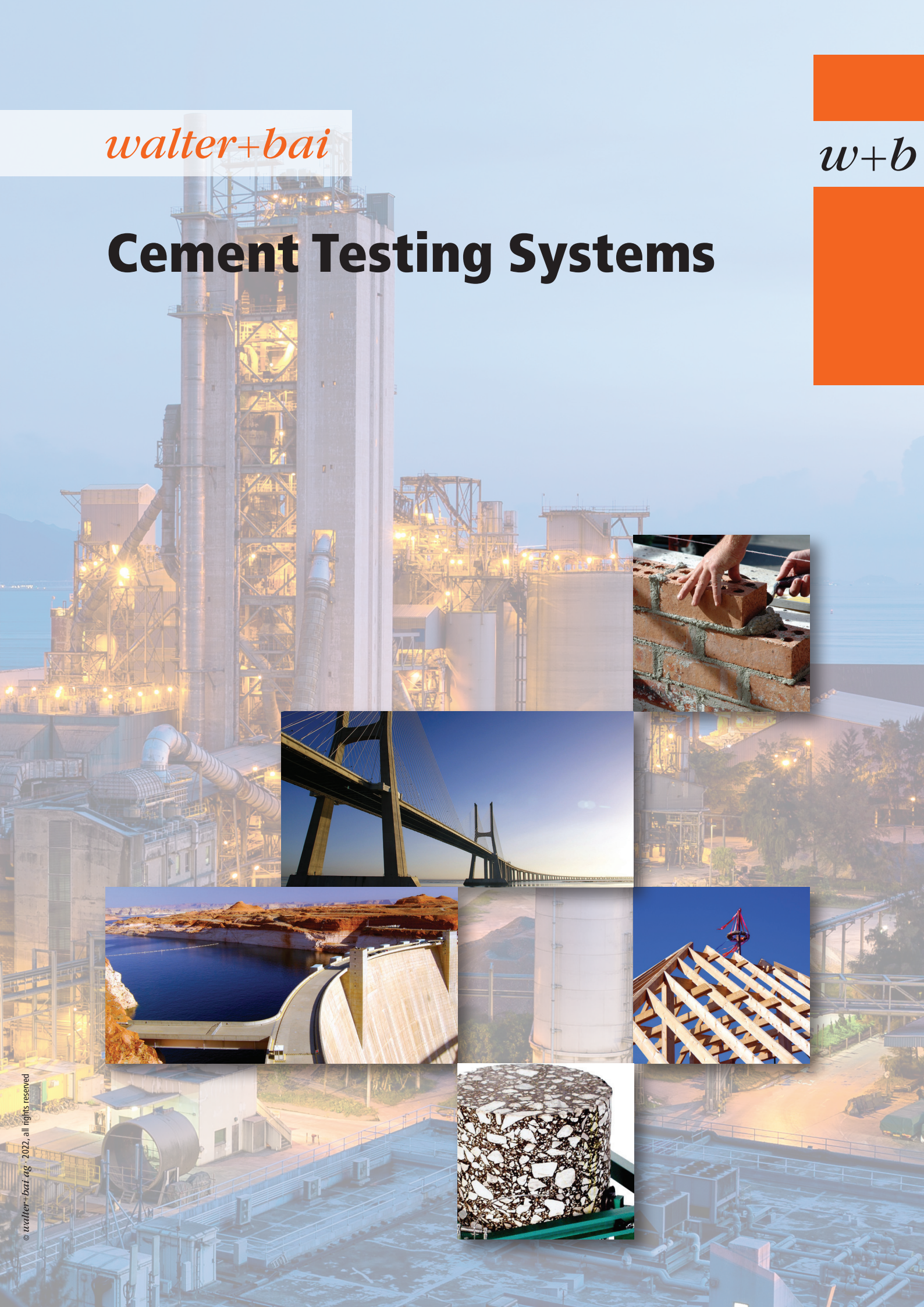

## Welcome by

*walter+bai*

Dear Customer

Mechanical testing plays a major role in research and education, product development, design and quality control.

In this Prospect we present the summary of our cement testing solutions which are globally employed by engineers and scientists to achieve the best results.

By selecting our equipment you benefit from our extensive experience in development and production of materials testing systems to suit numerous applications.

Should you require a very specific and customized testing system, we are able to design, develop and produce such system for you. We deliver customized solutions and complete installations for physical and mechanical testing laboratories world-wide.

Our prior goal is to supply advanced and up-to-date testing equipment designed for standard and severe conditions, coupled with long-lasting and reliable operation. To ensure that you obtain the maximum rewards from your investment, our accredited calibration laboratory guarantees an excellent after-sale service and verification facilities are always available for your installation. Our worldwide network of experienced representatives and qualified engineers provide you with optimum after sale support so that you thoroughly benefit from your testing system.

Please do not hesitate to inform us how we can make this catalogue better for you in the future. Your feedback and suggestions will be gladly received on [info@walterbai.com](mailto:info@walterbai.com).

Sincerely yours,

Ralph Walter  
Managing Director, walter+bai ag

## walter+bai Testing Machines



walter+bai ag Testing Machines supplies a wide range of material testing machines and systems for the safety and quality of materials, industrial products and buildings.

Mechanical testing is carried out in many industrial sectors, such as the automotive and aircraft industry, metal industry, plastic and rubber industry, the chemical industry, construction industry, bio mechanics as well as at institutes and universities. Serving these sectors for more than 50 years, w+b customers benefit from the company's extensive experience in producing material testing systems and equipment to meet this wide range of applications. Due to our comprehensive know-how and considerable engineering capabilities we are able to offer not only standard testing machines but also customized solutions or complete installations for physical testing laboratories world-wide. To ensure you obtain the maximum rewards from your investment, our accredited calibration laboratory guarantees that excellent verification facilities and after-sale service are available for your testing equipment.

### Profile

We are renowned for the production of high quality systems. Due to our continuous research and development policy as well as actively collaborating with our customers and suppliers we have always maintained the very high product standard ever since the company was founded in 1970 by Armin Walter and Alfred Bai in Löhningen - Switzerland. The sales, design and manufacturing divisions associated with testing machines has grown due to the constant interaction with a multitude of clients and the systematic realisation of their requirements. Our product range has been steadily expanded and our service sector activities extended to meet growing demands. The unique position of w+b in the field of material testing machines can be attributed to the fact that their specialised know-how related to materials testing is being constantly updated whilst offering custom designed products and services. A well qualified and highly motivated staff coupled with an efficient organisational structure forms the backbone of w+b upon which you can rely for know-how, competence and reliable performance.

### «Specific testing tasks demand appropriate testing equipment!»

This is our motto. Therefore, besides our standard range of testing machines, we have developed an extensive number of customized testing machines for static and dynamic material and component testing. w+b Testing Machines are the pacemaker for trendsetting technologies. They are a prerequisite for the safety and quality of materials, industrial products and buildings.

### Our Products and Services

- Manufacturing of materials testing machines and systems
- Customer specific testing systems
- Servohydraulic and electromechanical, static and dynamic testing machines
- Digital measuring and control systems and testing software
- Hydraulic power packs
- Static and dynamic actuator testing systems
- Accessories and fixtures for component testing
- Testing machines for construction materials
- Modernisation of existing testing machines
- Maintenance and calibration of material testing machines
- Project management and technical consulting



## Cement Testing Machines Series D, DB, D Super and DB Super

Serving the cement and building materials industry for more than 50 years, w+b benefits from rich experience in producing cement testing machines and equipment.

We are offering standard-compliant testing machines for cement and other binders testing. Due to our expertise in engineering of complex testing systems we produce and offer complete installations to physical testing laboratories worldwide.

Our current cement testing Platforms are the six generation of our D / DB and D / DB Super series and includes several enhancements related to ergonomic, advanced control and reliability. These test systems are available as single compression work space machine with 200, 250 or 300 kN capacity or with additional flexural test space with 10, 15, 20, 25 and 30 kN capacity.

They are designed to drive productivity in cement testing for carrying out compression and bending (flexural) tests on cement and mortar specimens 4 x 4 x 16 cm according to EN 196-1 and ISO 679, mortar cubes 2-inch or 50 mm according to ASTM C109, cubes 70.7 according to BS 4550 and other types of specimen as cubes, cylinders, cores, etc.



# w+b Materials Testing Systems

## Wide Range of Machines

w+b offers a wide range of different Cement Test Systems in order you will find a suitable testing machine from us according to your needs.

Our production range includes models:

- For compression testing only with optional manual split device for cement prisms
- Combined solutions for compression and flexural testing
- Models for standing or sitting operation
- Models for alternating or high-productive solutions for simultaneous testing
- Possibility to operate the testing machine stand-alone or in combination with our Proteus Application Software

## Reliable & Durable

Our prior goal, coupled with an experience of 50 years in the production of Cement Test Systems, is to deliver accurate and durable tests solutions to ensure that you obtain the maximum rewards from your investment.

w+b Cement Testing Machines combines proven load-frame design, reliable w+b servo-controlled hydraulic actuation combined with advanced high-speed, high-resolution digital closed loop control for trouble-free long-term operation.

## Accurate

Our Cement Testing Machines delivers repeatable and accurate test results as they incorporate features developed on our long experience.

- Machines equipped with bending—load cells for direct force measurement
- Differential actuators for most responsive control in combination with high-speed digital controller
- High-accurate analogue digital signal conversion with low noise
- Machines work with real closed loop control in combination with high-responsive servovalve
- High system stiffness for long-term repeatable testing
- And many others

## Versatile, Modular & Flexible

Our advanced machine design makes our systems not only best suited for the determination of the flexural and compressive strengths in the field of quality control but also compatible with a wide range of fixtures, extensometer and other accessories suitable for a wide range of demanding applications for research and product development.

These test systems are flexible and can be configured to different tests with different sample types.

The compression test space features a lower compression platen that is fixed to the piston rod end and an upper spherically seated platen fixed onto the load cell on crosshead. The distance between the compression platen is so that various compression devices and samples can be placed between the compression plates providing most universal testing virtually without any limitations.

The Flexural Beam with edges is fixed on the piston and the upper bending edge to the load cell. For carrying out alternative compression test on very low stress (load) mortars specimen (4 x 4 cm) a compression device can easily be placed into the flexural test space. For Elastic Modulus test on low strength samples a set of compression platen is available that can be used in the high resolution flexural test space.

## Latest Control Technology

All our Cement Testing Machines are closed loop through the latest digital control system DIGICON 4000.

This controller represents the latest generation of digital measurement and control system tailor-made for testing of building materials including cement, concrete, rocks, asphalt and soils. The DIGICON 4000 is the direct replacement of the DIGICON 2000 controller with consequent enhancement and continuous implementations of new standards, customer inputs, feedbacks and thousandfold successful installations across the globe.

The controller can be used in standalone operation, in combination with its large 7" colour touch screen with intuitive pre-defined test templates or in combination with the comprehensive Proteus application software.

## Proven Servohydraulic Actuation

All our cement test systems offer reliable w+b servo-controlled hydraulic actuation through real servovalve operation for the most reliable and accurate closed loop control in force / stress / deformation / strain or piston stroke control.

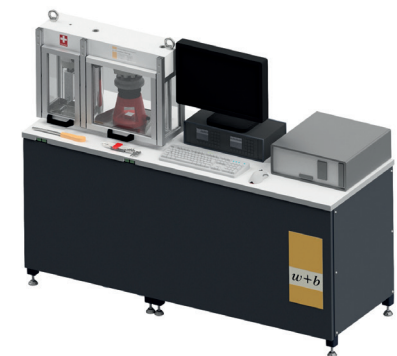
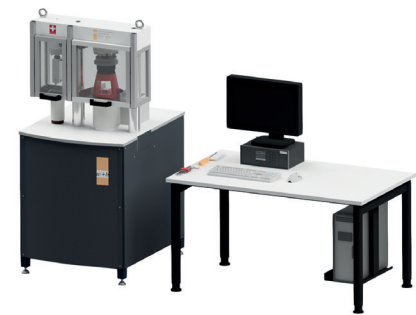

# w+b Materials Testing Systems

## Compact & Space-Saving

Our Cement Testing machines are compact and extremely space-saving servohydraulic test systems with in the base of the machines integrated hydraulic power pack.

## High Stiffness Load Frame

In order repeatable test results with smooth specimen breaking can be achieved and robust, durable and long-term trouble-free operation is assured our load-frames are designed with ultra-high load frame stiffness.

This superior axial stiffness minimize the stored energy in the frame that will abruptly release at specimen failure and cause shock to the specimen and machine.

## Low-Noise

The hydraulic power supply for the test system is integrated in the base of the machine.

The machine is designed in order it can operate with a system pressure below 300 bar. The hydraulic pressure and oil-flow is generated by a low-noise internal gear pump that works with low pulsations. The motor-pump group is mounted vertical on the tank so that the pump submerged into the oil. This compact design helps to reduce the noise level.

## Integrated In-Line Hydraulic High Pressure Filter.

The performance, life-time and reliability of servohydraulic test systems is acutely sensitive to the quality of the hydraulic oil. The experience of designers and users of hydraulic oil systems has verified that over 85% of all system failures are a direct result of contamination. As a consequence our power packs are equipped with In-Line Hydraulic Pressure Filters with absolute filtration of 10 µm to assure that clean oil. The size of the filters are large in order long service life of the elements are reached.

## High Efficiency Motor(s)

As part of a concerted effort worldwide to reduce energy consumption, CO2 emissions and the impact of industrial operations on the environment, various regulatory authorities in many countries have introduced or are planning legislation to encourage the manufacture and use of higher efficiency motors. Consequently all motors used in our test systems comply with the Premium Efficiency IE3 level according to IEC 60034-30-2008.

## Designed for Permanent Operation

The hydraulic power pack of the testing machine is cooled by an air-oil cooler or alternative available with oil-water cooling system and can be operated in permanently.

Integrated control and monitoring of the oil-temperature, filter element and oil-level is also provided

## Designed for Serviceability

Special attention was paid to the serviceability of our Cement Testing Machines. Parts are easy to clean and good access to hydraulic and electric installation is provided.

## Operator Safety

These test systems are designed with operator's convenience and health in mind.

Our D/DB series of test systems fully comply with the safety requirements of the EC Machinery Directive and are supplied with the related EC Declaration.

These test systems are designed with operator's convenience and health in mind.



## Comply with International Standards

Our Test Solutions are designed for the determination of the flexural and compressive strength according to international standards including but not limited to:

### EN 196-1:2016

This method describes the method for the determination of the compressive and, optionally, the flexural strength of cement mortar specimen 40x40x160 mm. The method applies to common cements and to other cements and materials, the standards for which call up this method.

### ISO 679:2009

ISO 679:2009 specifies a method of determining the compressive and, optionally, the flexural strength of cement mortar specimen 40x40x160 mm

### ASTM C109 / C109M-16

This test method provides a means of determining the compressive strength of hydraulic cement and other mortars using 2-in. or 50 mm cubes and results may be used to determine compliance with specifications. Further, this test method is referenced by numerous other specifications and test methods. Caution must be exercised in using the results of this test method to predict the strength of concretes.

### ASTM C349-18

This method provides a means of obtaining compressive strength values from the same specimens previously used for flexural strength determinations by Test Method C348. The compressive strength values are for reference purposes, and not as substitutes for values obtained by Test Method C109/C109M for cement acceptance.

### ASTM C348-18

This test method provides a means for determining the flexural strength of hydraulic cement mortars. Portions of the mortar prisms tested in flexure according to this test method may be used for the determination of compressive strength in accordance with Test Method C349.

## Ready for your Test Demands of Today & Tomorrow

To be prepared for the future, Proteus-MT is available with communication interface to several Laboratory Information Management Systems (LIMS) as:

- LIMS or CIMS of ABB
- Sauter
- La strada
- Lisa Lims
- Cobet
- Jouaux
- Limsophya
- FireQ
- Dorner
- LIS or PDV Dyckerhoff
- Limsophy
- and others

Our digital controller DIGICON 4000 can control monotonic servohydraulic as well as electromechanical AC or DC driven testing machines. In combination with servohydraulic test systems, this controller can control up to 4 testing machines / frames in alternating mode with one servo-valve. This assures you, that you will be able to connect additional load frames to your cement test systems as for examples concrete compression test frame to be operated with the control system of your cement testing machine.



## Compact Cement Testing Systems Series D and Series DB

These accurate and reliable Cement Test Systems incorporate all our innovations and latest developments in the field of cement testing.

The system's sturdy design delivery high precision & accuracy and ergonomically and intuitive operation simplify testing.

W+b Cement test systems deliver the capabilities test engineers and researchers need to perform high-fidelity tests that are vital to improving the efficiency, reliability and performance of cement testing.

Combining reliability and repeatability for quality control with an extensive functionality for research these systems give test professionals a fast, easy way to establish or expand in-house testing.

The compact systems are easy to install, operate and maintain. They leverage decades of w+b experience, offering a solution that demonstrates our commitment to providing high-quality systems for the full spectrum of cement and mortar testing.

### Features:

- Construction design and accuracy according to EN196-1, EN ISO 7500-1, EN 10002-2, NF P18411 Class 0.5
- The compression test assembly is placed between two columns and the flexural testing device on the left side
- Both compression and flexural test spaces are equipped with differential area actuators for the most responsive control, providing smooth and repeatable sample breaking
- Both compression and flexural test spaces are equipped with high precision load cells to achieve grade 0.5 measuring accuracy
- The various compression devices and samples can be placed between the compression plates providing most universal testing virtually without any limitations
- Machine equipped with real servovalve for reliable w+b servo-controlled hydraulic actuation with high-resolution & high-speed digital closed loop controls for the best test control even at low-speed and low-force
- For carrying out compression test on very low stress (load) mortars specimen (4 x 4 cm) a compression device can be easily placed into the flexural test space
- Machine delivered with protection device complies with the machinery directive 89/392/EEC and amending directives 91/368/EEC (29), etc.
- Extensive accessories are available including a range of extensometers





## Specifications D Model

Technical Data Model D		200	250	300
Force Range	kN	200	250	300
Force Measurement Accuracy	ISO 7500-1			
Grade 0.5			1% to 100%	
Grade 1			0.5% to 1%	
Piston Stroke (Kh1)	mm		50	
Test Chamber Height (Ph1)	mm		215	
Test Chamber Height (H1)	mm		568	
Test Area Width (Lw)	mm		320	
Column Diameter	mm		Ø 80	
Upper Compression Platen (Ød)	mm		Ø156	
Lower Compression Platen	mm		Ø200	
Hardness of Compression Platen	HRC		58-63	
Working Height (H2)	mm		945	
Frame Stiffness	kN/mm		1010	
Overall Width (W)	mm		540	
Overall Depth (D)	mm		746	
Overall Height (H)	mm		1633	
Weight	kg		360	
Power Requirements			400V, 50 Hz, 3 Phases, E, N (60 Hz on request available)	
Power Rating	kW	1.5	1.7	1.9
Operating Temperature Range	°C		15°C to +42°C	
Humidity Range	%		20-92%, Non-condensing	

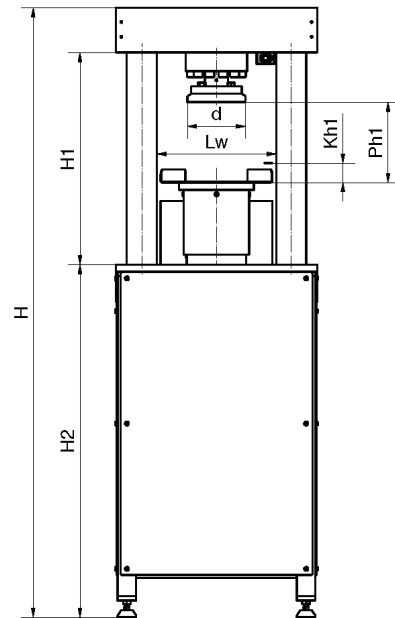
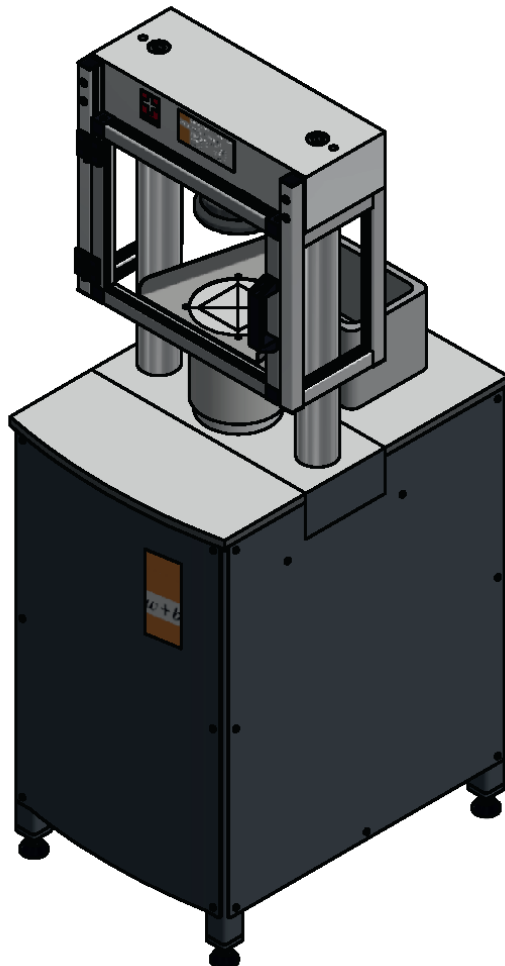

## Specifications DB Model

Technical Data Model DB		200/XX	250/XX	300/XX
Configurable with Bending Force	kN	10 or 15	10, 15 or 20	10, 15, 20, 25 or 30
Compression Frame				
Force Range Compression	kN	200	250	300
Force Measurement Accuracy	ISO 7500-1			
Grade 0.5			1% to 100%	
Grade 1			0.5% to 1%	
Piston Stroke (Kh1)	mm		50	
Test Chamber Height (Ph1)	mm		215	
Test Chamber Height (H1)	mm		568	
Test Area Width (Lw)	mm		320	
Column Diameter	mm		Ø 80	
Upper Compression Platen (Ød)	mm		Ø156	
Lower Compression Platen	mm		Ø200	
Hardness of Compression Platen	HRC		58-63	
Bending (Flexural) Frame Force Range	mm	10 or 15	10, 15 or 20	10, 15, 20, 25 or 30
Force Measurement Accuracy	ISO 7500-1			
Grade 0.5			1% to 100%	
Grade 1			0.5% to 1%	
Piston Stroke (Kh2)	mm		20	
Test Chamber Height (Ph2)	mm		219	
Test Chamber Height (Ph3) (distance between rollers)	mm		46	
Working Height (H2)	mm		945	
Frame Stiffness Compression	kN/mm		1010	
Frame Stiffness Bending	kN/mm		840	
Overall Width (W)	mm		750	
Overall Depth (D)	mm		955	
Overall Height (H)	mm		1633	
Weight	kg		460	
Power Requirements		400V, 50 Hz, 3 Phases, E, N (60 Hz on request available)		
Power Rating	kW	1.5	1.7	1.9
Operating Temperature Range	°C	15°C to +42°C		
Humidity Range	%	20-92%, Non-condensing		

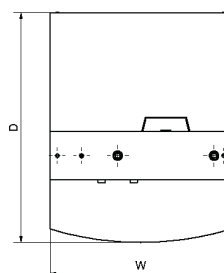
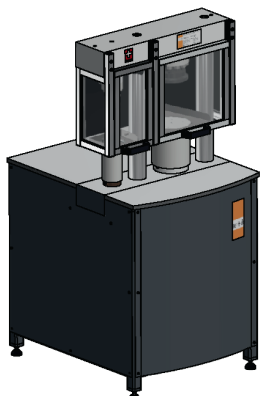
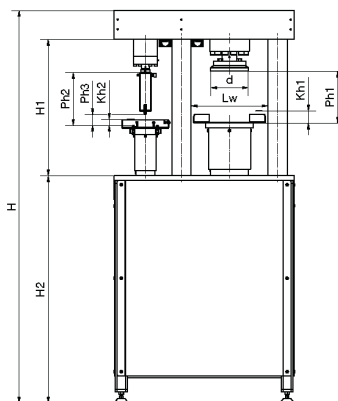
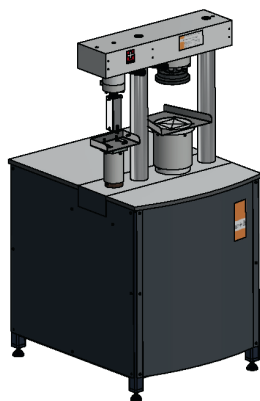

## Advanced Cement Testing Systems Series DB SUPER and Series D SUPER

These Testing Machines represents the most advanced models for high-productive testing, designed for voluminal testing in the field of cement quality control.

The SUPER series offers simultaneous bending and compression testing capability to reduce the testing time considerably.

These accurate and reliable Cement Test Systems incorporate all our innovations and latest developments in the field of cement testing.

The system's sturdy design delivery high precision & accuracy and ergonomically and intuitive operation simplify testing.

w+b Cement test systems deliver the capabilities test engineers and researchers need to perform high-fidelity tests that are vital to improving the efficiency, reliability and performance of cement testing.

Combining reliability and repeatability for quality control with an extensive functionality for research these systems give test professionals a fast, easy way to establish or expand in-hose testing.

The compact systems are easy to install, operate and maintain. They leverage decades of w+b experience, offering a solution that demonstrates our commitment to providing high-quality systems for the full spectrum of cement and mortar testing.

### Frame

- The machines are available as
  - combined compression and bending (**Series DB SUPER**) or as
  - compression only (**Series D SUPER**)
- Very rigid and precision aligned twin chromium plated column construction.
- Both testing frames have double acting rams for the quickest respond.
- Highest accuracy and repeatability achieved by precision load cells.
- Linear load increase in closed loop control with synchronized measuring channels.

- Both load frame are equipped with safety guard.
- The testing frames are mounted on a solid chassis.
- The chassis contains in the lower part the integrated silent hydraulic power pack with servo valve, oil-air cooling system.
- Rapid testing with automatic pre-load drive and unloading after specimen break with automatic test procedure. High flexibility by template generation and possibility of placing different devices in the machine.

### Control

- Servo-controlled test procedure in closed loop mode in connection with servovalve, digital controller **DIGICON 3000/4000** and building material testing software **PROTEUS-MT** for automatic test procedure, data acquisition, data analysis, print-out of test results and data storage in ASCII.

### Accessories / Options

- Simultaneous bending and compression testing to reduce the testing time.
- Test devices, extensometers
- Manual or hydraulic operated splitting device (Series D SUPER only)
- Interfacing Software to Central Laboratory Software as LIMS, CIMS, PAPA, Dorner a.s.o.



## Specifications

<b>Models</b>	Series DB Super	Compression and Bending combined.
	Series D Super	Compression only. Optional with split device.
<b>Force Capacities</b>	Compression	200 kN, 250 kN, 300 kN
	Bending	10 kN, 15 kN, 20 kN
<b>Control</b>	Closed loop control with automatic test procedure.	
<b>Accuracy</b>	In accordance with ISO 7500-1, Grade 0.5 or 1.	
<b>Power Requirements</b>	3 x 400 V, 50 Hz. Others upon request.	

Technical Data Type DB SUPER		200 / XX	250 / XX	300 / XX
<b>Overall System</b>		200 / XX	250 / XX	300 / XX
Overall Width (B)	mm	1840	1840	1840
Overall Depth (T)	mm	650	650	650
Overall Height (H)	mm	1403	1403	1403
Weight	kg	880	880	880
<b>Compression Frame</b>		200	250	300
Compression Capacity	kN	200	250	300
Accuracy Range	kN	2 - 200	2 - 250	3 - 300
Test Chamber Height (Ph1)	mm	215	215	215
Horizontal Daylight (Lw1)	mm	320	320	320
Upper Compression Platen Ø	mm	175	175	175
Lower Compression Platen Ø	mm	210	210	210
Piston Stroke (Kh1)	mm	50	50	50
System Oil Pressure	bar	165	205	250
Working Height (A)	mm	880	880	880
Load Frame Stiffness	kN/mm	1100	1100	1100
<b>Bending Frame</b>		10	15	20
Flexural Capacity	kN	10	15	20
Accuracy Range	kN	0.1 - 10	0.15 - 15	0.2 - 20
Test Chamber Height (Ph2)	mm	46	46	46
Bending Roller Ø	mm	10	10	10
Bending Roller Length	mm	50	50	50
Lower Support Span	mm	100	100	100
Piston Stroke (Kh2)	mm	20	20	20
System Oil Pressure	bar	185	275	365
Working Height (A)	mm	912	912	912
Load Frame Stiffness	kN/mm	200	200	200

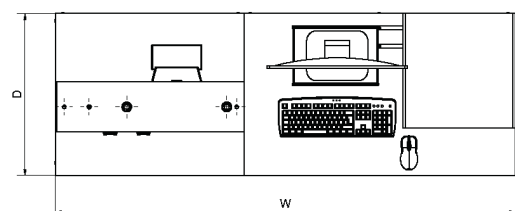
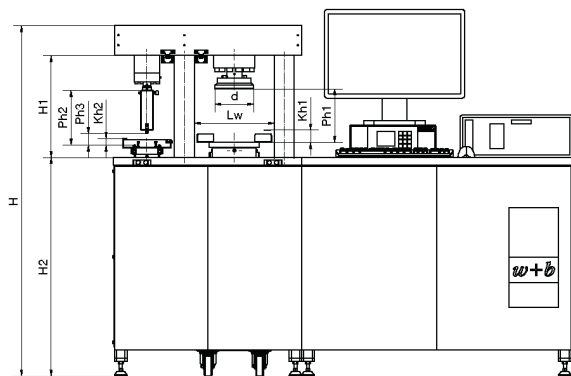

## Testing Devices according to International Standards for Cement, Mortar & Other Samples



### Manual Centring Compression Test Device Type DV 40 – H

This device is especially designed to carry out tests on broken mortar or cement prisms 4 x 4 x 16 cm according to EN 196-1. To be placed into the compression area in testing machines. The platens are made from alloy metal to assure a long durability. The upper platen is spherically seated with a mechanical horizontal and vertical orientation to assure no loop alignment error to the lower platen. An exact centring of the specimen is provided by a easy to use manual device.

Technical Data	DV 40 - H
Standards	EN 196 - 1, EN ISO 679, ASTM C349
Dimensions	Ø 175 x height 218 mm
Weight	14.5 kg

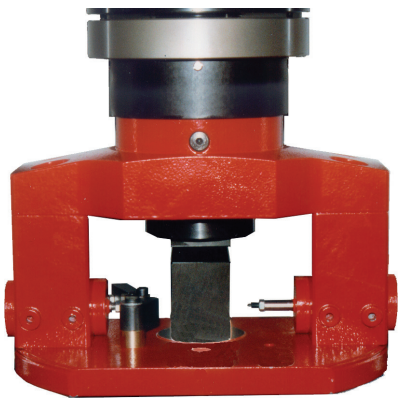

### Automatic Centring Compression Test Device Type DV 40 - A

This device is especially designed to carry out tests on broken mortar or cement prisms 4 x 4 x 16 cm according to EN 196-1. To be placed into the compression area in testing machines. The platens are made from alloy metal to assure a long durability. The upper platen is spherically seated with a mechanical horizontal and vertical orientation to assure no loop alignment error to the lower platen. An exact centering of the specimen is provided by a automatic system pneumatic or hydraulic operated that guarantees repeatability.

Technical Data	DV 40 - A
Standards	EN 196 - 1, EN ISO 679, ASTM C349
Dimensions	Ø 175 x height 218 mm
Weight	14.5 kg

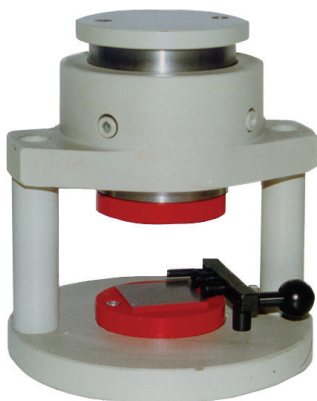

### Compression Test Device Type DV 50

For compression testing of mortar or cement prisms 50 mm / 2 inches according to ASTM C109. To be placed into the compression area in testing machines. An exact centring of the specimen is provided by a easy to use manual device. The platens are hardened (60HRC). The upper platen is spherically seated.

Technical Data	DV 50
Standards	ASTM C109
Dimensions	Ø 200 x height 218 mm
Weight	17.5 kg



### Compression Test Device Type DV 40 – 40

This compression device is especially designed for the determination of the compressive strength of mortar or gypsum sample prisms according to EN 196-1. To be placed into the flexural area of cement testing machines. The platens are made from alloy metal to assure a long durability. The upper platen is spherically seated. The device can be very easily placed into the flexural test space to assure a large resolution at lower forces.

Technical Data	DV 40 - 40
Standards	EN 196 - 1
Dimensions	Ø 65 x 150 mm
Weight	2.5 kg

## E-Modulus Compression Test Device Type DV - E

This compression device is specially designed to perform E-Module tests on low strength mortar or cement samples 40 x 40 x 160 mm according to EN 196 - 1. To be placed into the bending area in testing machines. The device can be very easily placed into the flexural test space to assure a large resolution at lower forces. The upper platen is spherically seated.

Technical Data	DV - E
Standards	EN 196 - 1
Dimensions	Ø 60 x height 50 mm
Weight	1.2 kg



## Flexural Test Device Type BV 10

Especially designed to carry out bending tests on mortar or cement prisms 4 x 4 x 16 cm according to EN 196 - 1. To be placed into the compression area in testing machines. The upper bearer moves vertically. One of the two lower bearers and the upper one can tilt horizontally. The distance between the two bearers is 100 mm.

Technical Data	BV 10
Standards	EN 196 - 1, EN 413 - 2
Dimensions	Ø 200 x height 210 mm
Weight	7.5 kg

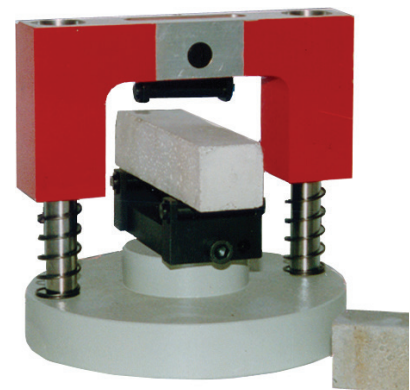

## Splitting Tensile Test Device Type SP 100

To insert into compression frame for testing carrots cylinders. Diameter: 5 to 10 cm. Max. length of specimen: 20 cm.

Technical Data	SP 100
Standards	EN 196 - 1
Dimensions	210 x 150 mm
Weight	1 kg



## Press Device Type PVP 40

This compression device is especially designed for the sample preparation of granulates, powder or other pressed pellet-samples. To be placed into the compression area in testing machines. This compression device is used to produce pellets samples needed for X-ray fluorescence analysis, testing of building lime according to EN 459 - 2, barytspats or other samples. It allows to produce pellets in the compression testing machine and it is not necessary to purchase a separate pellet press.



Technical Data	PVP 40
Standards	Various
Dimensions	Ø 200 x height 220 mm
Weight	10 kg

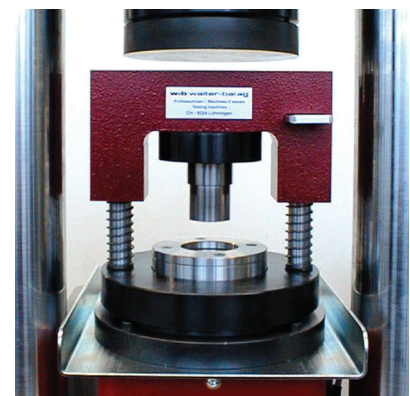

## Compression and Spacer Platens

To test various cubes or cylinders in the compression area of cement testing machines. Spacer platens are used to reduce the test chamber height. 1 platen Ø 175 mm x 40 mm and 4 intermediate platens Ø 175 x 40 mm or as requested.

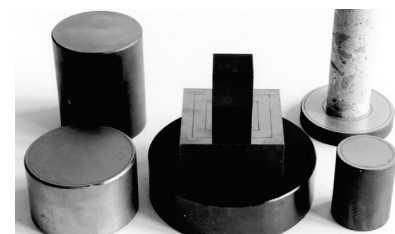

## Axial Extensometer (Compressometer) Type BD 25/50

The BD 25/50 axial extensometer is designed for the determination of the modulus of elasticity in compression of mortar, cement, concrete, rock and other materials.

The extensometer can be configured to be attached to cylinder, cores, and prisms in different dimensions.

This model measures axial strain on opposite sides of the test specimen with independent outputs making the BD 25/50 suitable for the determination of the Young's modulus on concrete in accordance with EN 12390-13, ASTM C469, ISO 6784 and DIN 1048-5.

The test procedure according to EN 12390-13 assess that the specimen centring should be controlled twice. The first time after the second loading and unloading cycle, and the second time after the third loading. After the second cycle of lading and unloading the deviation of the strain values of the two sides cannot excel +/-20% of the mean strain values. When the difference is greater, the specimen should be centred again. In the case of a second control, the difference may not exceed 10% of the strain average value.

When this extensometer is used with our Proteus application software, beside of the average value also both single values are displayed with automatic observation of the deviation in accordance with EN 12390-13.

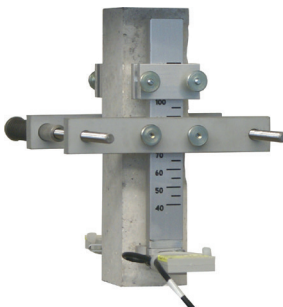
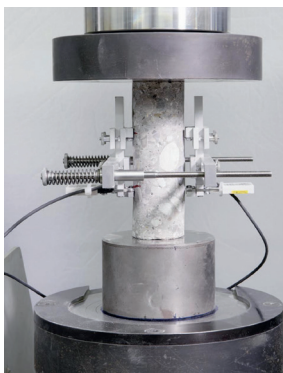

### Features

- Full bridge 350 ohm strain gaged design for compatibility with nearly any test system
- High accuracy unit
- Dual independent output (averaging box optional available)
- Suitable for large range of specimen sizes and shapes
- Easy mounting
- Self-supporting on the specimen
- Adjustable clamping force
- Supplied in high quality wood lined case

### Technische Daten

Measuring Range	±2 mm (⇒2 mV/V)
Measuring Accuracy	Grade 0.5 according to ISO 9513 ASTM class B-1
Linearity Error including Hysteresis	≤ 0.05 %
Gauge Length (adjustable)	40 – 220 mm
Quickset clamps for specimen	∅ and □: 30-160 mm
Sensor Type	2 x HBM – DD1
Temperature range	-10°C up to +60°C
Includes high quality wood lined case	

## Precision Universal Extensometer Type DBA 10

Designed for use where deformations must be measured in bending tests or where unusual geometries are involved. This extensometer can be connected to existing machines or to a separate digital display.

This precision extensometer is designed for the precision measurements until specimens failure where the extensometer is in contact against the specimen. The gauge arm is over-travel protected.

### Features

- Adjustable mounting block with magnet and precision displacement transducer
- Digital read-out in portable box for universal use on different testing machines or with signal conditioner integrated in the digital controller
- Including set of cables.

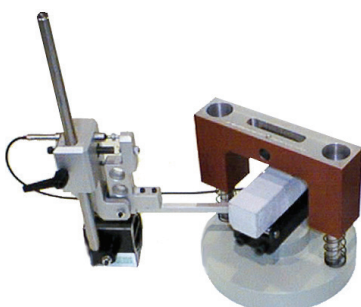

Technical Data	Type DBA 10
EN ISO 9513 Accuracy Class	1.0
Measuring Travels	5, 10, 20 or 25 mm
Length of Measuring Lever	200 mm
Displacement Transducer	LVDT

## Manual and Hydraulic Split Devices Type BV - H and BV - A 40 / 160

- To break the prisms 4 x 4 x 16 cm in two halves
- Manual Version: Manual one hand operation
  - Hydraulic Version: Automatic two-hand operation

Available additional to compression testing machines Series D SUPER or Series D.

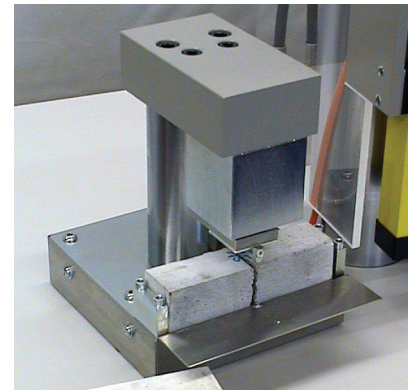

## Displacement Transducers Series WA

For accurate piston stroke measurement or closed loop control with fully data acquiritors into testing software PROTEUS-MT.

Graphs e.g. with force / displacement, displacement / time can be generated in the software.

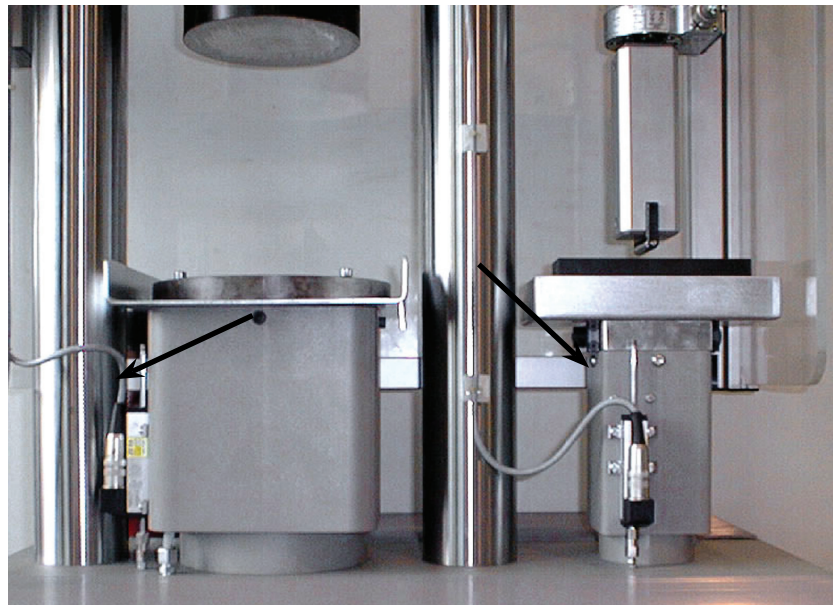



## Digital Control System DIGICON 4000 for Building Materials Testing Machines

DIGICON 4000 is the latest generation of digital measurement and control system tailor-made for testing of building materials including cement, concrete, rocks, asphalt and soils.

The DIGICON 4000 is the direct replacement of the DIGICON 2000 controller with consequent enhancement and continuous implementations of new standards, customer inputs, feedbacks and hundredfold successful installations across the globe.

The controller can be used in standalone operation, in combination with its large 7" color touch screen with intuitive pre-defined test templates or in combination with the comprehensive Proteus application software.



The DIGICON 4000 can control monotonic servohydraulic as well as electromechanical AC or DC driven testing machines.

In combination with servohydraulic test systems, this controller can control up to 4 testing machines / frames in alternating mode with one servo-valve. Typical applications are machine combination like cement testing machine together with a concrete testing machine controlled with one controller and one hydraulic system.



### Features:

- Application-Designed for closed loop control of building materials testing machines
- Simple operation as standalone unit with pre-defined test templates according to related standards with USB-Interface for Data export
- Advanced functionality in combination with Proteus Software Package.
- Latest controller generation provides long life-cycle
- Provides accurate closed loop control with closed loop control rate of up to 2000 Hz (2 kHz)
- High data acquisition rate on all channels
- Controller can be equipped with up to 8 amplifier cards with 18-bit resolution for data acquisition and control of force, displacement, strain and other sensors.
- Machine interlock direct from controller including protection device, quick piston drawdown, unpressurized circulation etc.

## Reliable

This latest generation of data acquisition and control unit reflect the knowledge and best practices gained from decades of experience. The unit includes consequent enhancement and continuous implementation of hundredfolds successful installation across the globe since early 1970's.

## Versatile

The DIGICON 4000 can be configured to control servohydraulic as well as electromechanical testing machines. With its up to 8 available channels for data acquisition and control this controller can be configured to meet your unique needs of today and can be extended in the future when your test needs would change.

## Accurate

The DIGICON 4000 digital controller offers 2000 Hz closed loop control rate and 1000 Hz data collection on all channels. This enables you to generate high resolution test data for analyses. The high speed closed-loop control rate assures high control accuracy and repeatable tests.

## Compatible with Digicon 2000

The DIGICON 4000 is designed to direct replace the Digicon 2000. This makes it easy to upgrade your existing test system with this latest generation of digital control system.

## Flexibility through Electronic Data Sheet (TEDS)

The DIGICON 4000 features an intelligent transducer plug system featuring an incorporated electronic data sheet that will be automatically recognized and read by the digital controller. The characteristics as electronic label, specifying sensor type, operating range, coefficients for linearization, transducer calibration etc. are stored in the form of an electronic data sheet.

Once the transducer is connected to the amplifier card of the DIGICON 4000 the information will be read and imported. It gives the laboratory the flexibility to connect and transducer with electronic data sheet to any available DIGICON 4000 controller in the laboratory without quick plug and play installation and without the need of execute a calibration of verification procedure.

## Operator Safety

The controller fully comply with current safety requirements. Protection devices can be connected direct to the controller.

## Standalone Operation

The controller can be used in easy-to-use standalone operation, in combination with its large 7" color touch screen with intuitive pre-defined test templates.

The DIGICO 4000 offers an extensive and growing library of standards-compliant test methods and free to program sequences and full complement of accessories for cement, concrete, asphalt, wood and other materials testing.

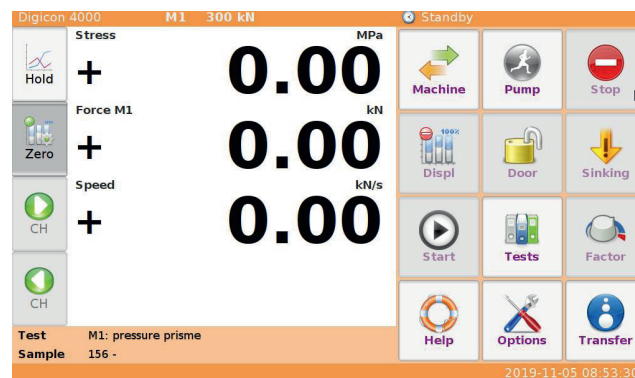

Main Screen

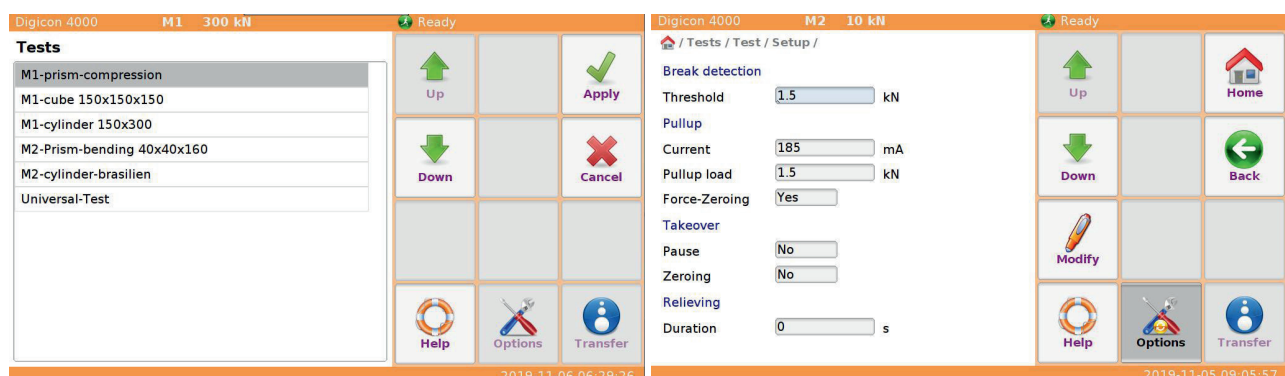

Template Selection

Adjustement Screen

## Export

This controller offers the test data export even when used at standalone unit without application software Proteus. The test data are saved as XML-File and can be exported via USB port to your host system for data backup, data processing, creating your own reports or import into an existing laboratory information management system (LIMS).

## External Remote Touch Unit

The DIGICON 4000 can be supplied with external Remote 7" color touch screen that allows to install the operating touch screen up to 2.5 meter away from the controller.



Technical Data	
Closed-loop control rate	2 kHz
Data acquisition rate	1kHz
Measurement channels	max. 8
Analogous resolution	18Bit with SAR-Technology
Control Inputs	6 Optocoupler configurable
Control Outputs	9 Relais configurable
Signal Inputs	10V, SSI and Increment
Valve	24V Proportional Valve Servovalves
Electromechanical drive	Module for DC and AC motors
PC-Interface	Ethernet / LAN
I/O-Interfaces	USB
Intelligent Display	intern or remote
Capacitive Touch-Screen	7inch HDMI 1024x 600 Pixel
Options	
Amplifiers	4 Dual MV11
Type	DMS-LVDT-SSI or Potentiometric
Teds-Connector	1-wire EEPROM for the Linearisation

## Testing Software for Building Materials PROTEUS-MT

We offer flexible and powerful building materials testing software. Available are different software packages in accordance with the relevant international standards.

The packages offers fully automatic control of the test procedure and data collection of results including analysis and reporting. Control and evaluation has never been as user-friendly as it is now when using these application packages.

These packages offers you both, rapid and productive testing but also specialized applications for advanced testing requirements.

The screenshot shows the ProteusMT software interface. The main display area features the company logo and contact information for w+b walter+bai ag. The right-hand side contains a 'Setup window' with fields for 'Servo' (Zement), 'Machine' (M1 Druck), and 'State'. Below this are 'Control actions' (Up, Down, X.1, X.10, X.100, Spiking) and 'Machine channels' (Zerlong, Software, Hardware) showing 'Kraft/Druck 300 300.00 kN' and 'Min 0.0 Max 0.0'. The 'Machine interface' section is currently empty. The bottom status bar shows 'Administrator' and 'Zwischenablage ist leer.'

**PROTEUS<sup>MT</sup>**

Prüfmaschinen Machines d'essais Testing Machines

**w+b walter+bai ag**

Industriestrasse 4, CH - 8224 Löhningen, Switzerland  
Tel. +41 (0)52 687 25 25      www.walterbai.com  
Fax +41 (0)52 687 25 20      info@walterbai.com

 EN ISO 9001  
Quality Management System

 SCS 068  
Swiss Calibration Service

## Testing Software for Building Materials PROTEUS-MT

PROTEUS-MT offers many advantages in the field of building materials testing. Test control, data collection and evaluation and reporting capabilities have never been as user-friendly. PROTEUS-MT offers both, rapid and productive testing but also specialised applications for advanced testing.

### Features

- The high degree of flexibility brought by template generation and by the test editor allows configuring the program according to the exact specifications needed.
- PROTEUS-MT is not only used in cement and ready-mix plants, building material test laboratories, but also for R&D in technical universities.
- Standard test types according to current standards, can be expanded in a modular way.
  - Option: test editor, to define custom-specific test sequences
- Supports all widely used sample bodies with no dimensional limitations.
- Standard tests and special tests defined and stored as test templates. (Parameters set automatically according to the Standard used.)
- Custom test templates can be scaled according to the number of measurements, of decimal places, etc.
- Keying in an order and testing as separate activities.
- Mixed tests within a single test order (e.g. Elasticity Modulus and Pressure Test, etc.)
- Log output (including charts) according to type of test and of sample.
  - Option: form designer for custom adaptation of log.
- Structured Database (SQL) with additional custom data that can be defined at every level (Order-Series-Sample), Object-Oriented, Modular and Network-Ready
- Data export in ASCII-format.
  - Option: additional processing in external software such as your Laboratory Information Management System.
- Supports measuring devices such as measuring station, scales and slide gauges.
- Password protection for sensitive functions (H/W configuration, templates, etc.)

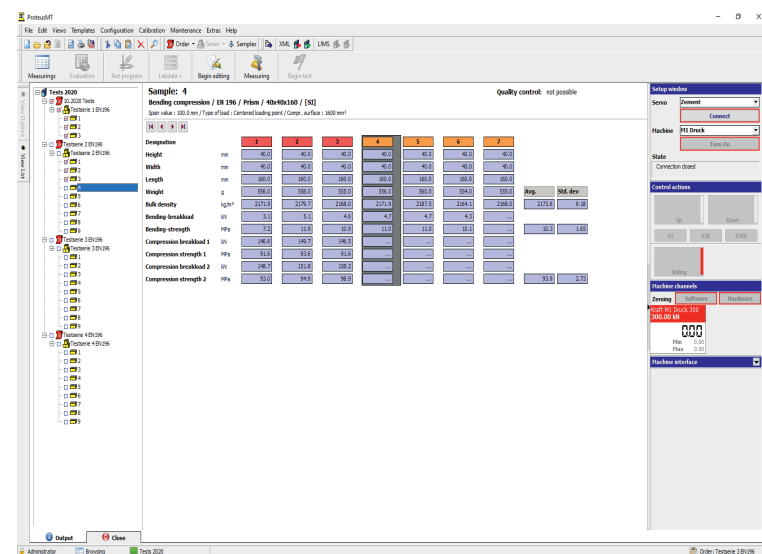
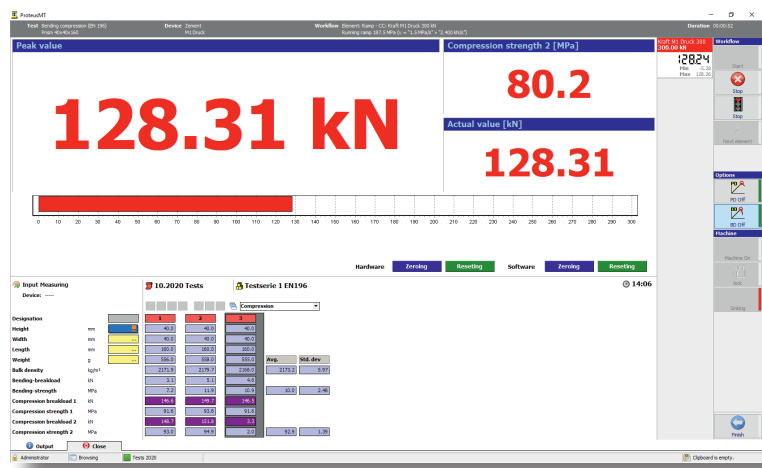

## Testing Software for Building Materials PROTEUS-MT

### Templates Make Testing Fast and Easy

Test templates contain all parameters needed for testing, such as Type of Sample, Type of Test, Test Standard, Quality Control, Graphical Representation and more. Several tests within a single order performed by assigning a test template to the series. Custom-made additional test templates can be defined in addition to the standard ones.

### Simple to Operate

- All program functions can be selected with the mouse. The main functions may also be called with a combination of keys. Powerful object-specific functions called directly with the right mouse button to speed up operations: Copy, Paste, Clear
- Test classification in a relational database
- Database Structure: Databases can be structured according to any suitable folder hierarchy. Thus, tests can be sorted according to individual criteria, e.g. according to customers or suppliers, materials, type of test, time scales, test bodies. Each database contains any number of orders and series. A series contains at most 99 samples. Example: An order contains 3 series (Age 2, 7 and 28 days), each one with 3 samples.
- Data Export for Additional Processing: The data export function provides an interface with other external programs and stores the data in standard ASCII format. Option: Customer-specific ASCII formats.
- Logging: All series in an order can be printed out. The type of form is correctly handled by the Logging Manager, based on the test template. Option: Form Designer for custom-specific adaptation of forms.

### Standard Sample Bodies

Depending on the type of test and the standard, the following approved sample bodies are available:

- Cubes:  
10, 15, 20 cm, 4, 6 inch
- Cylinders:  
10 x 20, 12 x 36, 15 x 15, 15 x 30,  
16 x 32, 20 x 20, 20 x 40 cm
- Drilling Cores:  
50 x 50, 50 x 100, 80 x 80, 80 x 160 mm
- Prisms:  
40 x 40 x 160 mm
- Bars:  
10 x 15 x 70, 12 x 12 x 36,  
15 x 15 x 70, 20 x 20 x 90 cm
- Plates:  
60 x 60 x 10 cm

Dimensions to be selected without limitations.

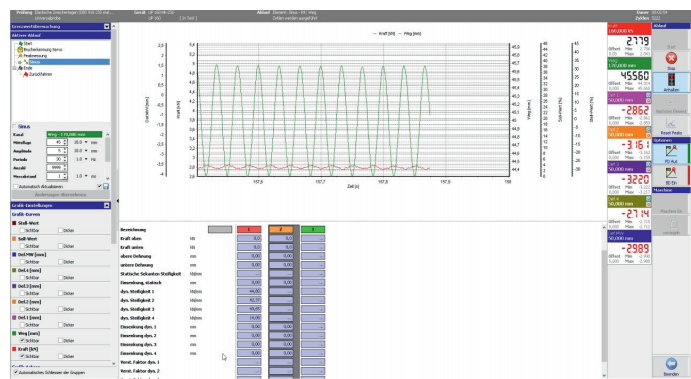
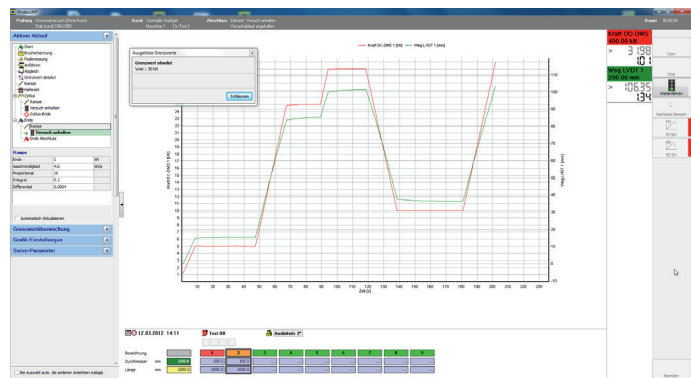
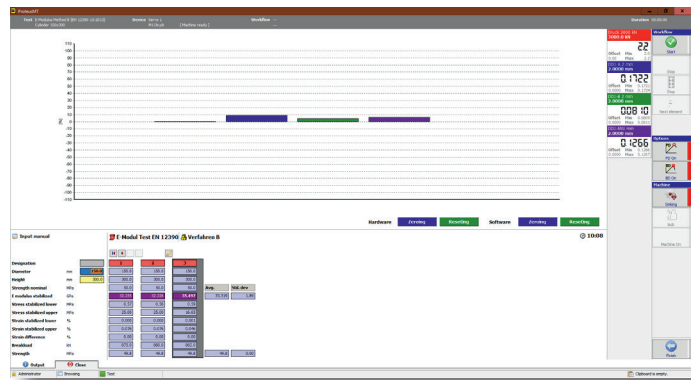

## Testing Software for Building Materials PROTEUS-MT

### PROTEUS-MT Basis Module

- Data base contains a sample administration.
- Actual test and printer list with calendar make the daily work easier
- Connection of several controllers or measurements with up to 4 machines each
- is possible.
- For the combination bending-compression test 2 controllers are simultaneously in operation.
- Works with sliding gauge, balance, dial gauge and digital measuring station.
- Templates simplify the tests fundamentally. They are made with help of an assistant.
- Universal and special tests can be arranged on a graphically surface.
- Automated routine tests are easily created
- Password protection for the laboratory head for templates and hardware adjustments
- Standard export of the results in the ASCII-format for further processing in other programs
- Standard protocols for all tests, optional with or without graphic.
- Number of digits and rounding of the results can be indicated in the templates.
- Laboratory data base for further data fields in the order or series with choice of data, text and numeric fields with description and sorting
- Program for the calibration of the machine with DIGICON 2000/3000

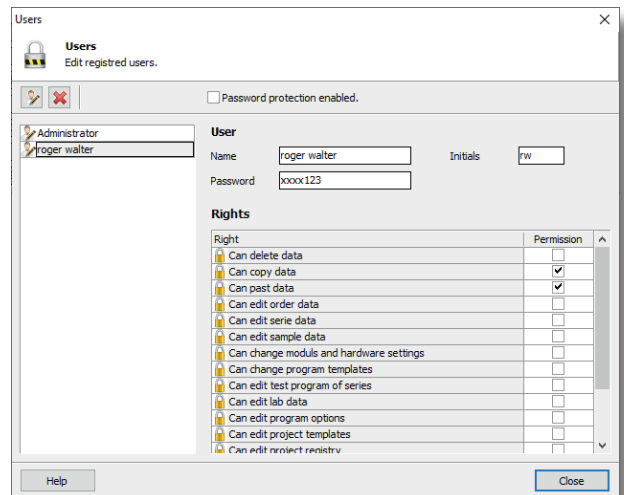
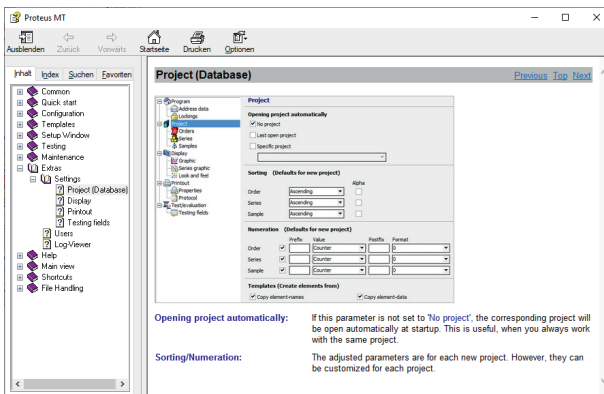
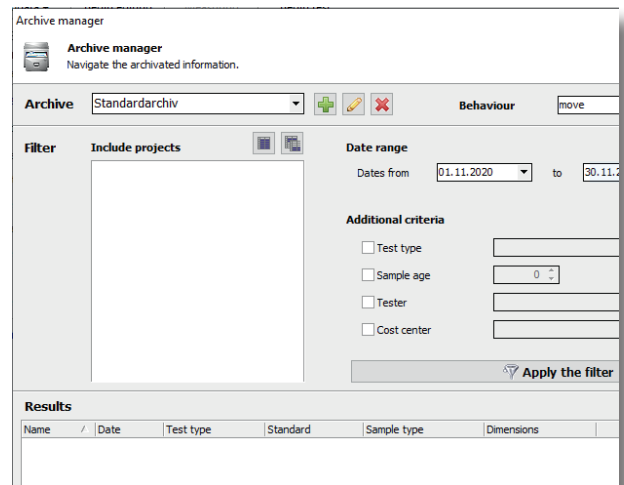
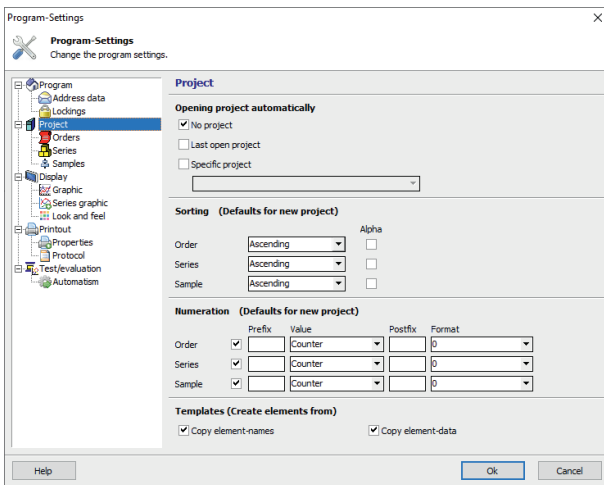

## Cement and Mortar Testing

For the automatic determination of the flexural strength and compression strength of cement and mortar samples

- The testing in series allows calculation of mean and standard deviation
- Graphical analysis of force, deformation and deflection
- Sample administration with acquisition at time of delivery / production and testing of samples with date according test list
- Deformation control allows closed loop tests with force maximum
- Inputs of values from electronic sliding gauge and balance
- Simultaneous bending and compression testing with 2 machines controlled

### Bending and Compression Tests

**Standards** EN 196

**Samples** prisms, cubes, cylinders

**Determination** flexural strength, compressive strength

**Calculations** density



## Concrete Testing in accordance with Relevant International Standards

w+b offers a wide range of testing machines for different concrete tests. Each system can be individually configured according to your testing needs for an optimal solution.

Concrete is a construction material composed of cement as well as other cementitious materials such as fly ashes and slag cement, aggregates made from crushed rocks such as limestone or granite, plus a fine aggregate such as sand, water and chemical admixtures.

Concrete solidifies and hardens after mixing with water and placement due to a chemical process known as hydration. The water reacts with the cement, which bonds the other components together, eventually creating a stone-like material. Concrete is used to make pavements, pipe, architectural structures, foundations, motorways/roads, bridges/overpasses, parking structures, brick/block walls and footings for gates, fences and poles.

In this section you find a wide range of testing machines for the determination of the strength of concrete.

In addition we offer a wide range of testing equipment for the determination of workability, consistency, setting time, volumic mass, air content, linear variations as well as for the sample preparation a.s.o.

All testing machines and equipment conforms to the relevant international standards as EN, ISO, ASTM and other corresponding national standards.

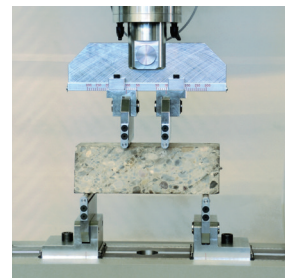

## After Sales Service

The world-wide network of w+b highly qualified factory trained support staff provides customers with comprehensive after sales solutions for w+b testing systems.

We are focused on the individual customer support and the offered services include on-site installations, repairs and maintenance throughout the entire life cycle of your testing equipment. Customers of w+b know they can benefit a maximum from the acquired testing equipment, and with provided after sales service they are in good hands – now and in the future.

### Over 50 Years of Experience

- Customers prefer w+b because of our individual customer approach coupled with flexibility and versatility in developing the most customized and specific testing systems.
- However there is more. By choosing a testing system from w+b you start a long-term partnership with us.
- With our world-wide network of w+b highly qualified support and maintenance engineers provides you with an optimum after sales support, to make sure you get the most from your investment.
- w+b constantly invests in hiring and training service engineers and local representatives.
- w+b provides customers with comprehensive free of charge telephone support of all specialists for the lifetime of the product.
- Our large stock of spare parts from the most w+b equipment helps you to minimize the idle time in case of problems with equipment.
- w+b test systems are designed for stable and long term operation. With the provided constant comprehensive service and support you will profit the maximum from your systems throughout their entire life cycle.

### Instruction Manual

At w+b a comprehensive customer support starts with a detailed instruction manual. To each system we deliver a complete technical manual including information about safety, system installation, machine set-up, technical drawings of testing system, hydraulic and electric schemes with items list, software and hardware manuals, maintenance information, a.s.o. By providing from very beginning this technical information to our clients, which is later on demand complemented by telephone support, enables us to have practically more than 90% of all shut-downs solved instantly.

### Installation and Warranty

Our qualified field service engineers are available in short terms to install and to commission your testing system on site after its delivery. All our field service engineers are factory trained and complete the installation in a timely manner. Our service guarantees the reliable commission and operation of your testing system according to the technical specification. All w+b products are covered by a factory warranty.

### Customer Training

It is essential that our clients use w+b testing systems to its full extent, i.e. by employing all possible features and capabilities of the acquired equipment. Additionally, as a well-known fact the comprehensive knowledge of machine operation practically reduces the instrumental setup times, also prevents possible mistakes and in turn increases your testing efficiency. Therefore, the technical instruction and extensive operation training are provided by w+b engineer at the time of system's commissioning. Further repetitive training, organized either on site or at w+b premises, ensures that new system's operators from customer side are properly instructed on the operation capabilities of the installed system, likewise the skills of already trained operators are refreshed and retained. We provide an extensive range of comprehensive training courses focused on complete machine operation, software usage, sample alignment, all types of materials tests, and many others. These courses can be scheduled with a short notice and given either at w+b or at your premises.

### Hardware & Software Support

To ensure that the acquired system can be steadily employed even though your testing requirements are changing with the time, our software and

hardware engineers, including w+b local representatives, will assist you with these tasks, as well as you will receive the detailed information on w+b continuous development of software and hardware. This will guarantee that your system is maintained at peak performance. Through planned and systematic service visits of our engineers for preventive maintenance and calibration of your testing system, any potential problems can be identified beforehand and resolved immediately avoiding unnecessary machine's idle time.



### Calibration

w+b calibration laboratory is accredited according to the latest ISO EN IEC 17025 (formerly EN 45001) standard. The calibration and verification of your materials testing machine is a part of our provided service. Our field service engineers are not only trained to perform maintenance and calibration service on w+b machines, also the testing machines of other producers are successfully verified and calibrated in a daily manner. The calibration certificate will prove the verification of your system conforming to ISO 9001 and other standards.

### Application Service

We consult customers concerning testing techniques and provide with necessary tools, as well as we create report templates or graphic presentations precisely suited to your specification, developed based on w+b standard software packages. Our application experts have many years of experience in development of materials testing applications and will create a product to fully meet your requirements.

## Maintenance and Calibration of Materials Testing Systems

by *w+b* Accredited Calibration Laboratory

The maintenance and service works on your materials testing equipment is executed by our specialists with highest attention and precision, and with experience of over 45 years. Highly precise computer-aided calibration equipment guarantees a calibration according to the latest international standards.



SCS 0068

Our calibration laboratory is certified according to ISO/IEC 17025 which is recognized through the Multilateral Agreement (MLA) for EA - European Cooperation for Accreditation. The maintenance and calibration performed by our specialists with 45 years of experience assure a reliable execution of the service. Your savings: there are no extra costs for an additional calibration by a further official calibration institute, since we are an accredited calibration laboratory.

We will calibrate your test equipment independently of the type and manufacturer. We offer excellent conditions together with flexible dates. The accreditation according to ISO/IEC 17025 is recognized through all signatories of the EA (European Cooperation for Accreditation) multilateral agreement of calibration.

### *w+b* Calibration Laboratory is accredited for:

- Force - Tension, Compression
- Pressure
- Length - Displacement, Deformation
- Hardness
- Energy - Impact Tester

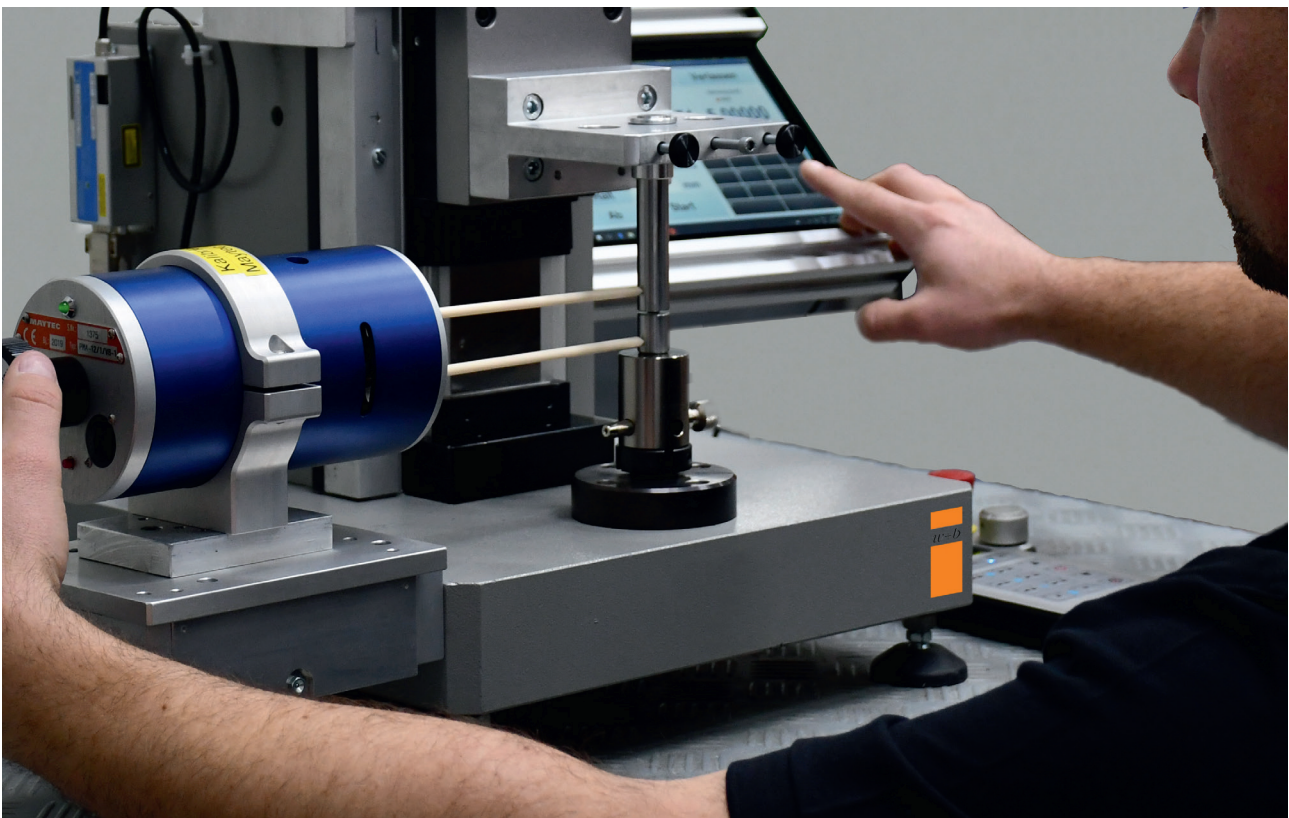



*walter+bai*

**walter + bai ag  
Testing Machines**

Industriestrasse 4  
8224 Löhningen · Switzerland

Tel. +41 (0)52 687 25 25

Fax +41 (0)52 687 25 20

info@walterbai.com · www.walterbai.com

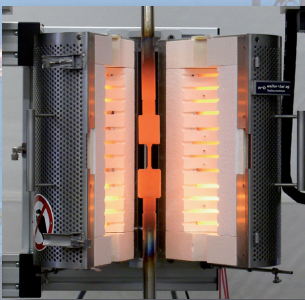

- Static Universal Testing Machines, Electromechanically or Servohydraulically driven
- Dynamic Multipurpose Testing Systems for Advanced Material and Component Testing
- Torsion, Rotary Bending, Impact Pendulum Testing Machines
- Hydrostatic Pressure Testing Systems
- Customer Specific Testing Machines, Modernisation of Existing Testing Machines

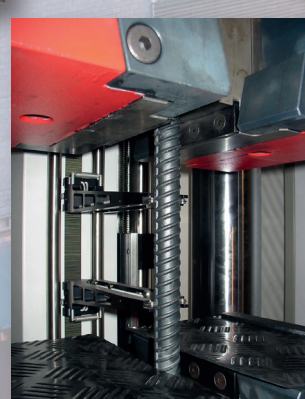
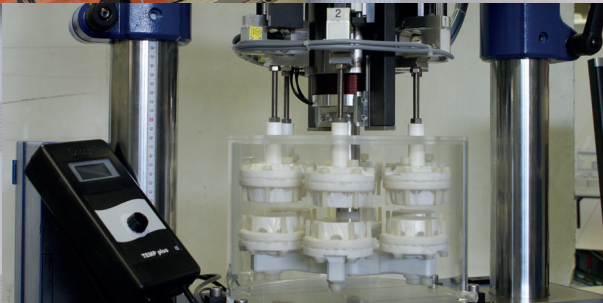
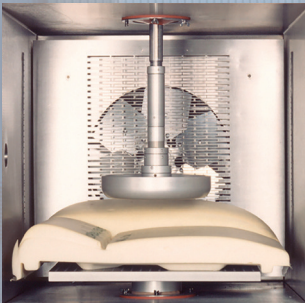
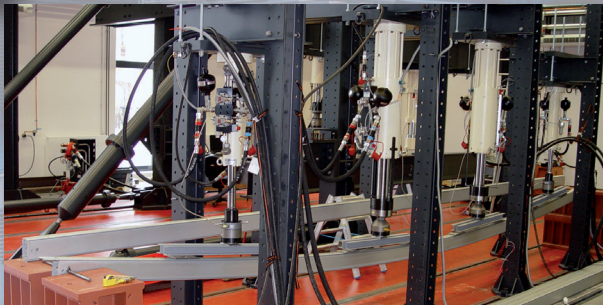

- Accessories for Material Testing, incl. Digital Controllers, Application Software, Hydraulic Power Supply, Grips and Fixtures, Extensometers, Furnaces and Climatic Chambers, a.s.o.
- After-Sale Service at Customers Laboratory
- Calibration of Material Testing Machines